



BIOPROCESS SINGLE USE BAG

**ISO 13485
Clean Room Class 10,000
R&D Center**

New Future Smart Bio Technology

E-100 Technical data of Polyethylene Film

Main applications areas : Biotechnology applications, high oxygen barrier.

Film thickness : 0.325mm

Formulation characteristics : Multi layer structure with inert PE fluid contact layer,
low extractables / leachables.
No animal derived components.

Pharmacopoeia compliancy and biocompatibility :

- ISO 10993-4 Hemolysis
- ISO 10993-5 Cytotoxicity
- ISO 10993-6 Implantation test
- ISO 10993-10 Irritation and Sensitization tests
- ISO 10993-11 Acute Systemic Toxicity test
- USP <85> Bacterial Endotoxins – LAL Test
- USP <85> Biological reactivity testing, in vivo, class VI
- USP <661> Plastic Containers
- European Pharmacopoeia tests, Ch, 3.1.5

Copies of the test reports are available upon request.
Gamma sterilization dose 25kGy except **50kGy



• POLYETHYLENE TANK LINER

Catalog No	Tank Liner
ESL-0050	50Liter
ESL-0130	130Liter
ESL-0200	200Liter
ESL-0340	340Liter
ESL-0400	400Liter
ESL-0560	560Liter
ESL-0790	790Liter
ESL-1090	1090Liter



• POLYETHYLENE 2D SINGLE USE BAG

Catalog No	2D Single Use Bag
ESD-001	1Liter
ESD-002	2Liter
ESD-005	5Liter

PORT 1	Silicone tubing, Pinch clamp MPC Male Connector 1/4" ID + Cap
PORT 2	Silicone tubing Pinch clamp MPC Male Connector 3/8" ID + Cap
PORT 3	Silicone tubing Pinch clamp MPC Male Connector 3/8" ID + Cap

Catalog No	2D Single Use Bag
ESD-010	10Liter
ESD-020	20Liter
ESD-050	50Liter

PORT 1	Silicone tubing, Pinch clamp MPC Male Connector 1/4" ID + Cap
PORT 2	Silicone tubing Pinch clamp MPC Male Connector 3/8" ID + Cap
PORT 3	Silicone tubing Pinch clamp MPC Male Connector 3/8" ID + Cap

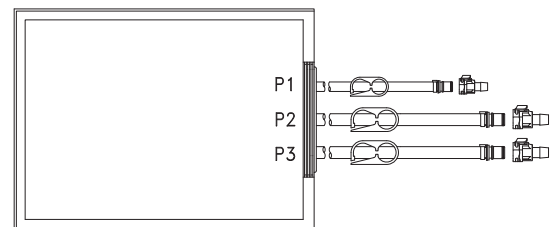
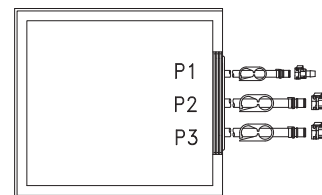

• POLYETHYLENE 3D SINGLE USE BAG

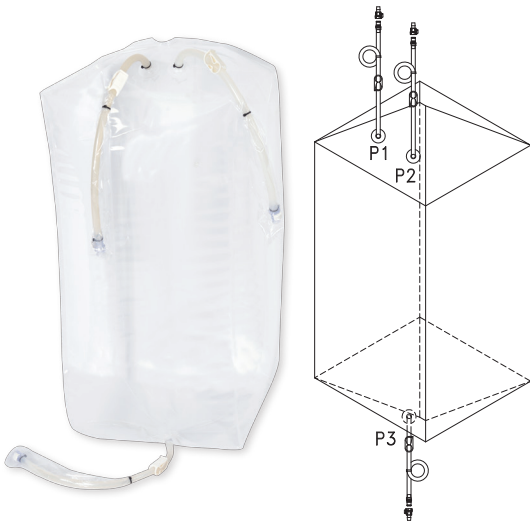

Catalog No	3D Single Use Bag
ESP-0050	50Liter
ESP-0100	100Liter
ESP-0200	200Liter
ESP-0500	500Liter
ESP-1000	1000Liter

PORT 1	Silicone tubing Pinch clamp MPX Male Connector 1/2" ID + Cap
PORT 2	Silicone tubing, Pinch clamp MPX Male Connector 1/2" ID + Cap
PORT 3	Silicone tubing Pinch clamp MPX Male Connector 1/2" ID + Cap

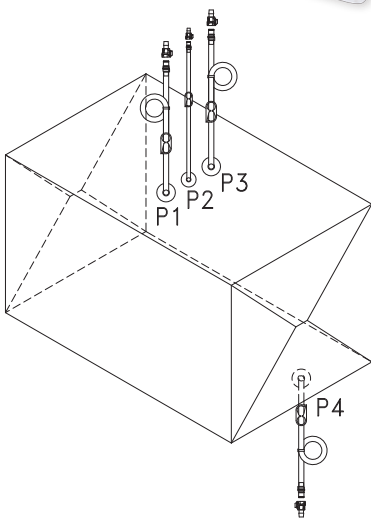

Catalog No	3D Single Use Bag
ESS-0200	200Liter
ESS-0300	300Liter
ESS-0500	500Liter
ESS-1000	1000Liter

PORT 1	Silicone tubing Pinch clamp MPX Male Connector 1/2" ID + Cap
PORT 2	Silicone tubing Pinch clamp MPX Male Connector 1/2" ID + Cap
PORT 3	Silicone tubing Pinch clamp MPX Male Connector 1/2" ID + Cap
PORT 4	Silicone tubing Pinch clamp MPX Male Connector 1/2" ID + Cap

• POLYETHYLENE 3D SINGLE USE MIXER BAG

Catalog No	3D Single Use Mixer Bag
ESM-0050	50Liter
ESM-0100	100Liter
ESM-0200	200Liter
ESM-0500	500Liter
ESM-1000	1000Liter

Mixer	Magnetic Coupling Type
PORT 1 (Bottom)	Silicone tubing Pinch clamp MPX Male Connector 1/2" ID + Cap
PORT 2 (Side)	Silicone tubing, Pinch clamp MPC Male Connector 1/4" ID + Cap
PORT 3 (Top)	Silicone tubing Pinch clamp MPX Male Connector 1/2" ID + Cap
PORT 4 (Top)	Sanitary Port 3S Packing + Blank + Clamp

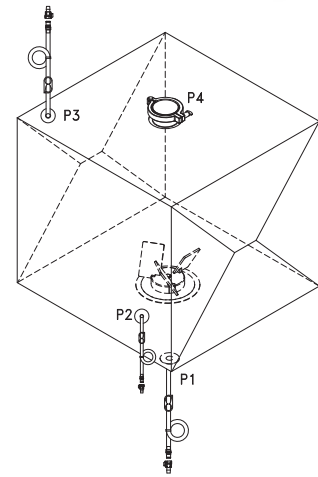

• POLYETHYLENE 3D SINGLE USE BIOREACTOR BAG

Catalog No	3D Single Use Bioreactor Bag
ESR-0050	50Liter
ESR-0100	100Liter
ESR-0200	200Liter
ESR-0500	500Liter
ESR-1000	1000Liter

Drive	Bottom Magnetic
Gas Inlet system	Sparger
Impeller	Marine or Turbine Type
Top Port	3S Port , Exhaust Port, Spare Port
Side Port	Sensor & Sampling

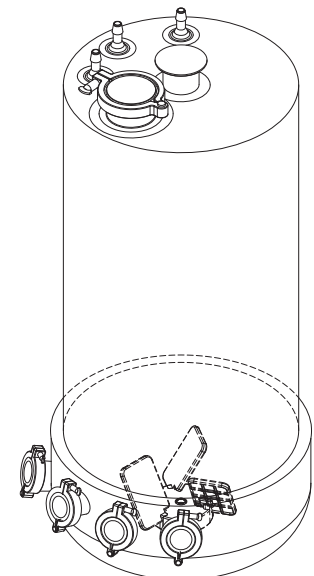

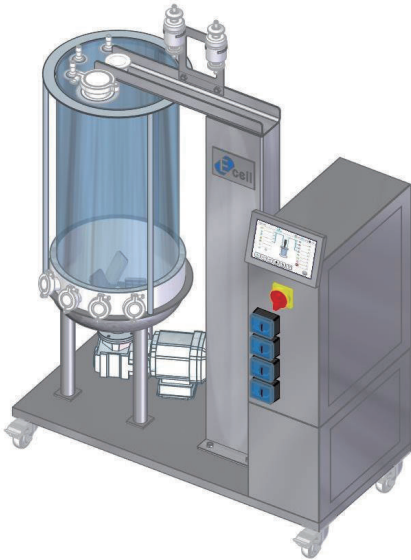

• SINGLE USE MIXING SYSTEM

Single Use Mixing System					
Catalog No	ETM-0050	ETM-0100	ETM-0200	ETM-0500	ETM-1000
Volume	50L	100L	200L	500L	1000L
Material	Stainless Steel				
Drive	Magnetic Drive, IP65				
Load Cell	Option				

• SINGLE USE BIOREACTOR

Single Use Bioreactor					
Catalog No	ETR-0050	ETR-0100	ETR-0200	ETR-0500	ETR-1000
Volume	50L	100L	200L	500L	1000L
Material	Stainless Steel				
Drive	Bottom Magnetic Drive, IP65				
Gas Inlet system	Sparger				
Side Port	Sensor & Sampling				
Load Cell	Option				

• SINGLE USE BAG CONTAINER

Catalog No	3D Single Use Bag Container
ETC-0200	200Liter
ETC-0300	300Liter
ETC-0500	500Liter
ETC-1000	1000Liter

Design and Quality

Customizing Single Use System





← CLEAN ROOM 1 - Sealing Room

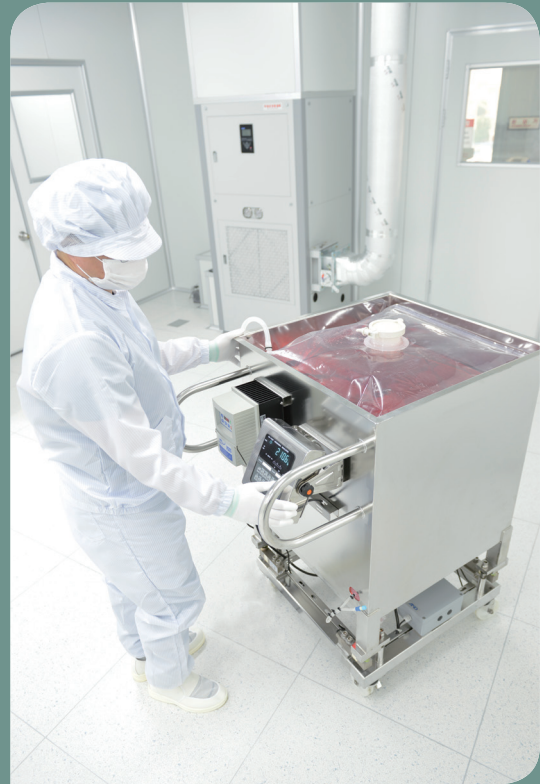

↑ CLEAN ROOM 2 - Test Room

← CLEAN ROOM 3 - Film Digital Cutter



BIOPROCESS SINGLE USE BAG



TEL : 032-715-8077
FAX : 032-715-8078
WWW.ECELLPROCESS.COM
ECELL@ECELLPROCESS.COM